

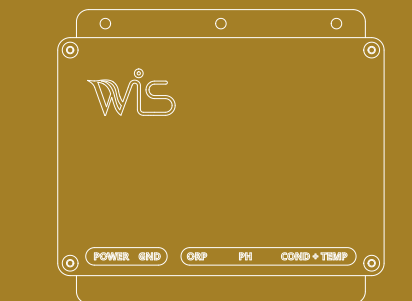

# WIS IN LINE QUICKSTART GUIDE

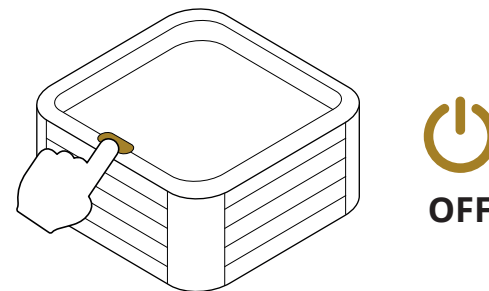

## 01



**Power off the spa**  
For your safety, it is best to turn off the main power supply

## 02

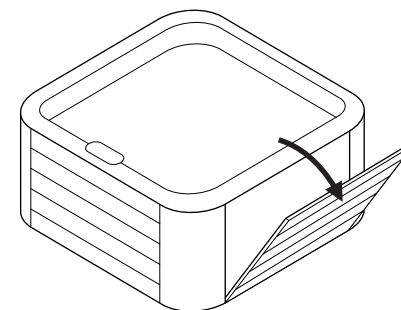

**Open the side panel of your spa to access the unit control box**



Installation must be done by a professional

## 03

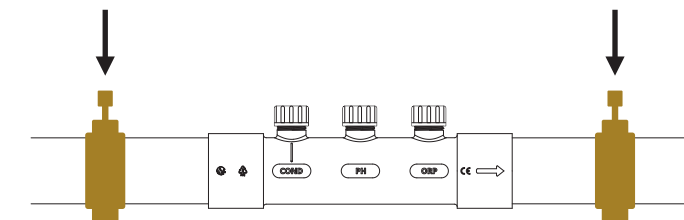

**Close the slice valves**

## 04

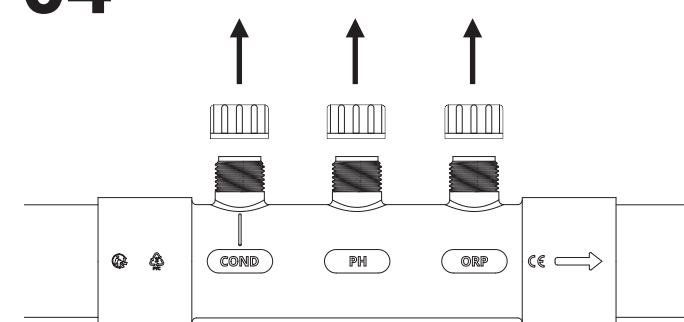

**Remove the manifold caps**

## 05



1

2

3

4

5

**Install the compression fittings**



Store the sensor boxes and end caps

## 06



Turn conductivity sensor:  
water flow passing through the hole

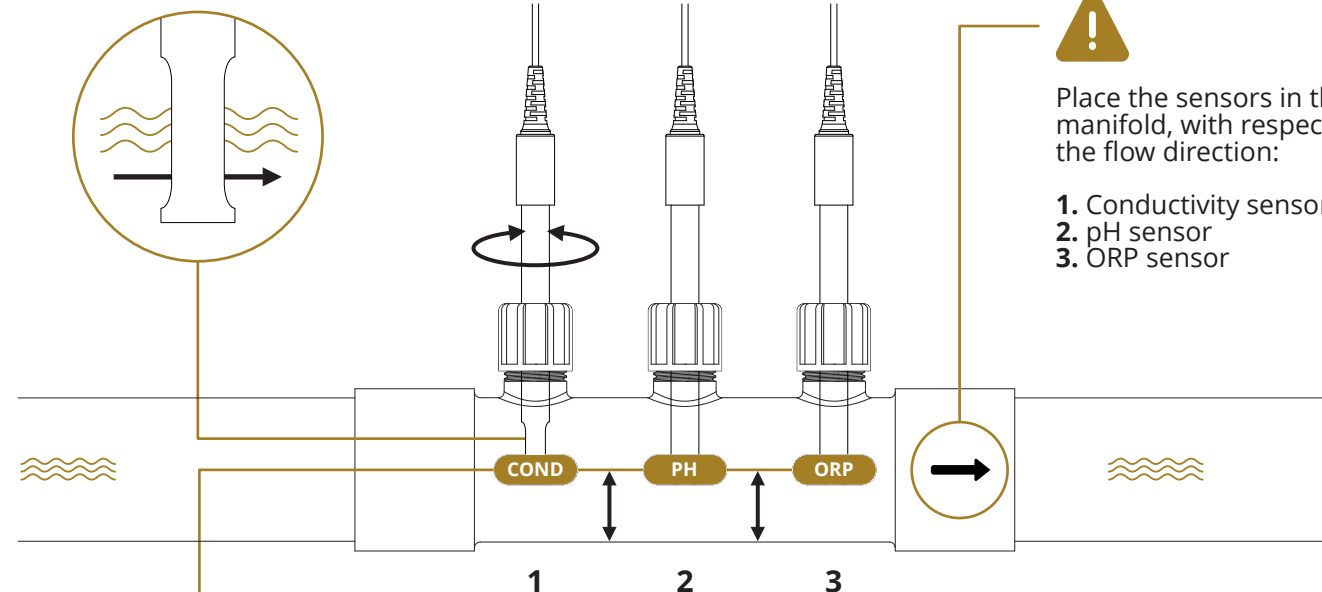

Place the end of the sensors in the middle of the manifold

**Screw the sensors on the manifold**



Place the sensors in the manifold, with respect to the flow direction:

1. Conductivity sensor
2. pH sensor
3. ORP sensor

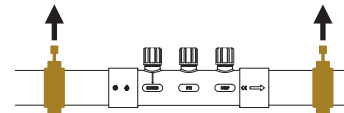

**Open the slice valves**

## 07

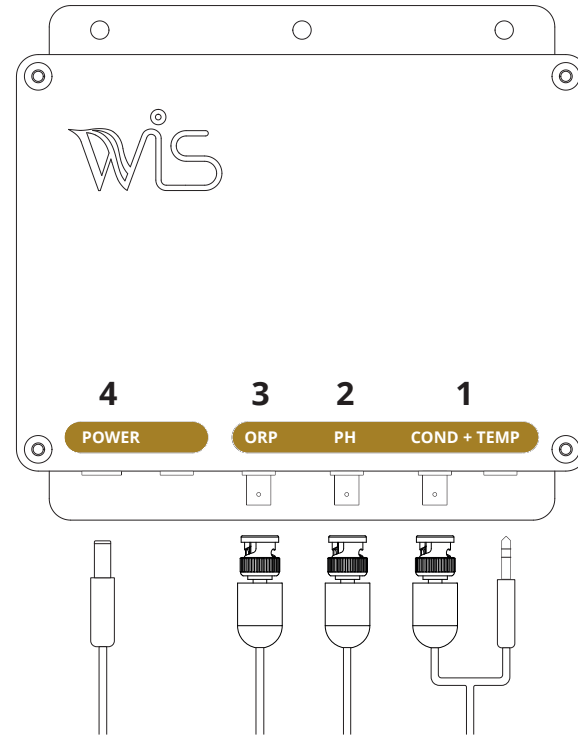

**Connect the sensors to the control box**

08

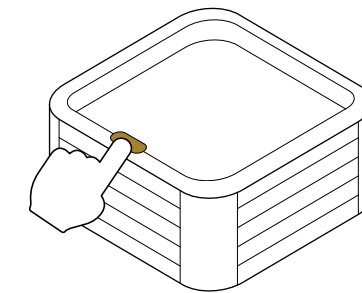

Restore the power supply to the Spa to turn on WIS IN LINE

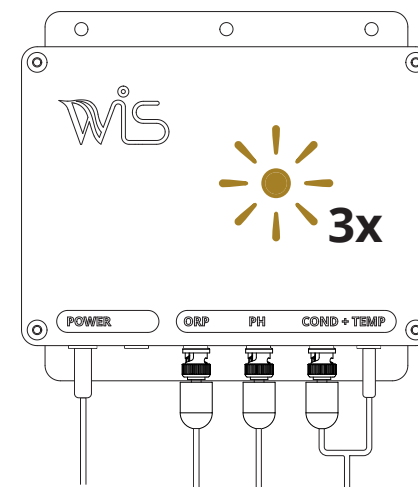

09



WIS - CONNECTION TO YOUR SPA



Download the application (free App)



Download the application on the user's phone

10

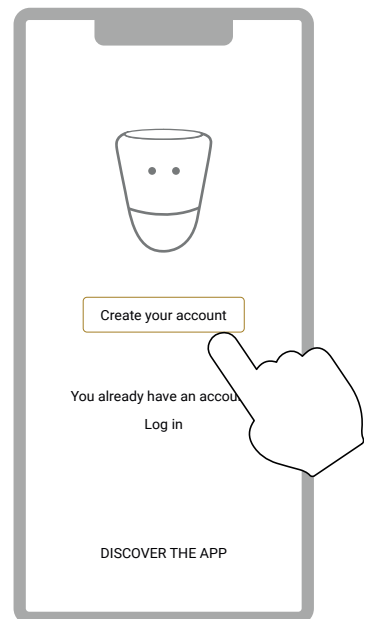

Create your account

11

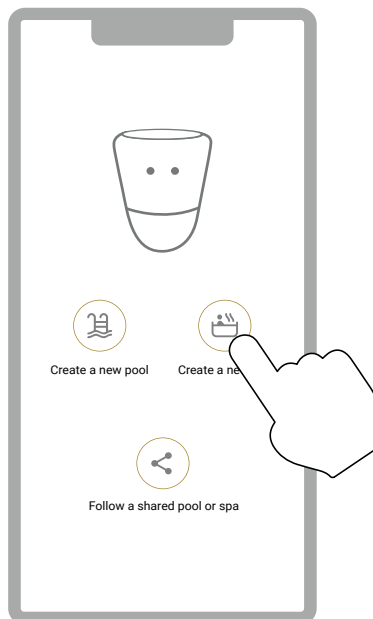

Create a new spa

12

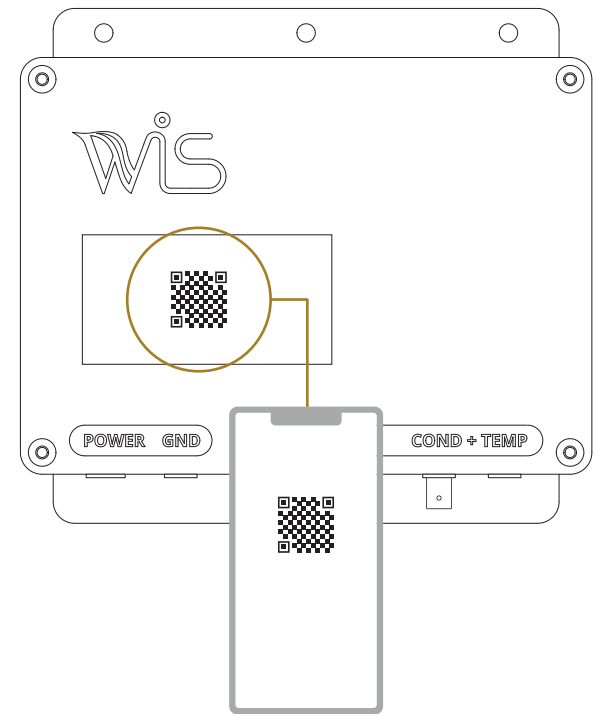

Scan QR code and follow the instructions

13

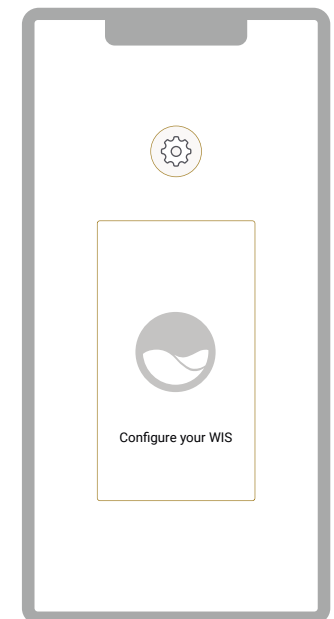

Configure your WIS

Follow the WiFi connection steps in the app

Wellis

www.wellis.com



ANY QUESTIONS?